

DETAILS

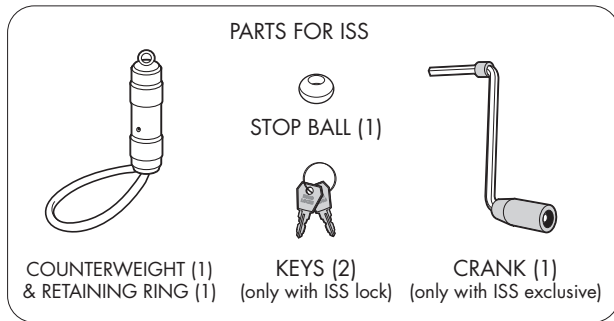
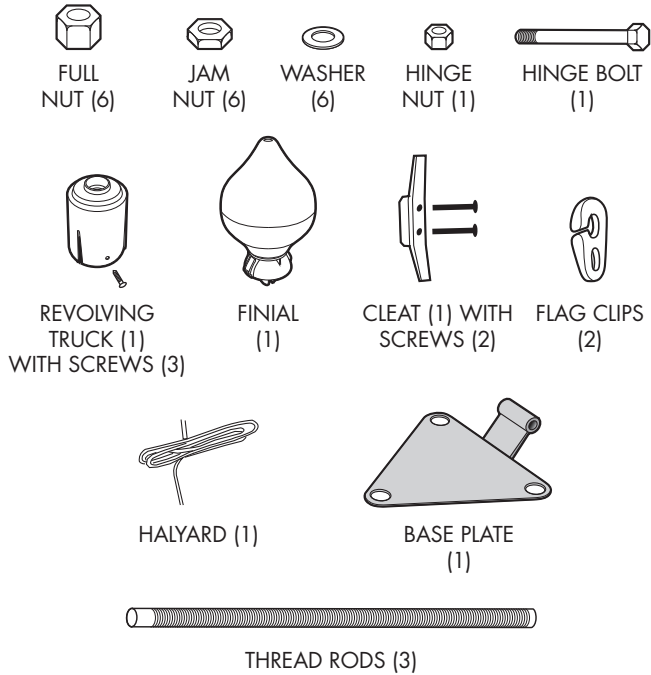

CARING FOR YOUR FORMENTA FLAGPOLE

Check that top nuts are tight and make sure that halyard is in good shape on a regular basis.

When needed, clean the flagpole using hot water and soft soap. Use car wax to maintain the finish.

IMPORTANT: When flying a vertical banner with an internal halyard system, plastic slings must be used (one per meter recommended).

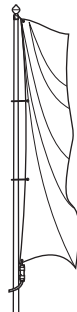

INSTALLATION INSTRUCTIONS

5-12 m

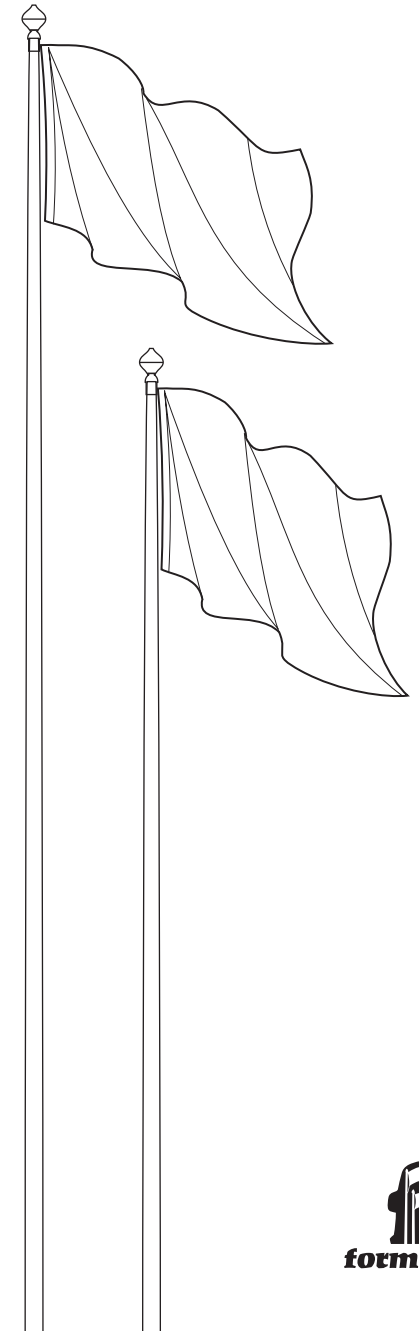

Box 525, SE-331 25 Värnamo, Sweden
 Phone: +46 (0)370 692550 | Fax: +46 (0)370 49128
 info@formenta.se | www.formenta.se



1 FOUNDATION

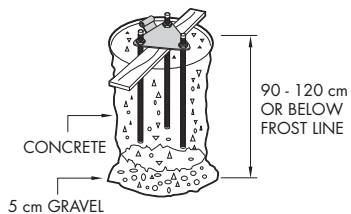

HOLE PREPARATIONS

1. Dig hole according to chart recommendation. If the ground is soft or sandy, increase the diameter of the hole.
2. Fill bottom 5 cm of hole with crushed stone.

HOLE DIMENSIONS

FLAGPOLE	5-6 m	8 m	9 m	10 m	12 m
Diameter (cm)	35	35	40	45	45
Depth (cm)	90	90	100	120	120



* Recommended dimensions for normal ground conditions.

ASSEMBLING GROUND SET

1. Secure lower hinge plate (B) to anchor rods by first threading down bottom jam nuts (C), placing over hinge plate and securing top jam nuts (C).
2. Once both elements complete, fill hole with concrete. When inserting ground set, make sure hinge bolt is in a position to allow for raising and lowering clear of obstruction.
3. Press ground assembly into centre of hole. Keep lower base plate above concrete with the assistance of wooden plank. Using a spirit level, check for levelness.

ALLOW CONCRETE TO CURE

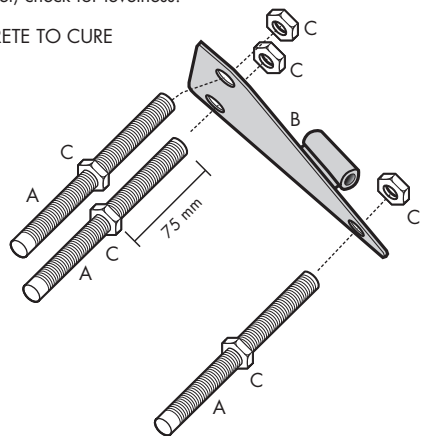

2 FINIAL AND HALYARD

1. Thread halyard through revolving truck and fasten truck to top of flagpole using 3 supplied screws.
2. Fix cleat to flagpole.
3. For ISS (Internal Safety System), slip counterweight (D) over pole and tie to end of halyard. Use the stop ball.

When no flag is attached to the flagpole, make sure that counterweight sits at the very top of the flagpole.

EXTERNAL HALYARD

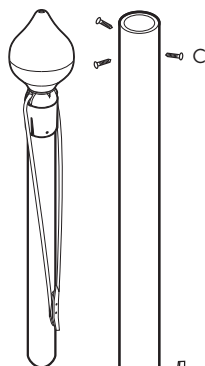
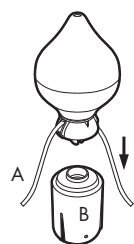

ISS

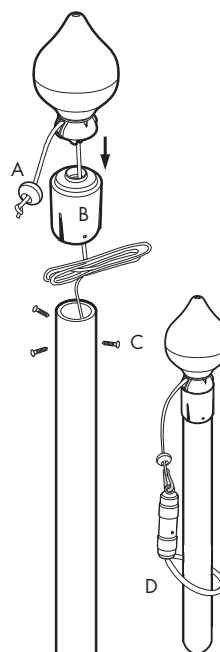

3 RAISING THE FLAGPOLE

1. When the concrete is firmly set, the flagpole can be raised. Bring base of flagpole to lower base plate, thread lower full nuts (F) and washers (G) onto anchor bolts leaving 35 mm of exposed rod. Fasten hinge bolt (H), joining lower hinge base and flagpole base together.
2. Raise the flagpole. Place washers (G) and top full nuts (F). Through slight adjustments to full nuts, pole can be re-leveled. DRAW TIGHT.

NOTE: After several weeks, check that top nuts have stayed tight and tighten as required.

